

E-Bike-Battery Supercore

OPERATING INSTRUCTIONS



IDENTIFICATION

PRODUCT

Model: Supercore

- Art. No. 37146-00 (Brose 20 Ah)
- Art. No. 37146-01 (Shimano 20 Ah)
- Art. No. 37146-04 (Brose 20 Ah GPS)
- Art. No. 37146-05 (Brose 15 Ah)
- Art. No. 601401 (Shimano 15 Ah)
- Art. No. 601488 (Brose 20 Ah without cover)
- Art. No. 601489 (Shimano 20 Ah without cover)
- Art. No. 601590 (Alber 20 Ah)

Country of Origin: Germany

Mark: CE

MANUFACTURER

BMZ Batterien-Montage-Zentrum GmbH
Zeche Gustav 1
63791 Karlstein
Germany

Ph.: +49 (0) 6188 9956-0

Fax: +49 (0) 6188 9956-900

E-mail: kontakt@bmz-group.com

Web: www.bmz-group.com

CUSTOMER SERVICE

BMZ Service Center
Am Sportplatz 15-17
63791 Karlstein am Main
Germany

Ph: +49 (0) 6188 9956-9833

Fax: +49 (0) 6188 9956-699

E-Mail: cs.ebike@bmz-group.com

Web: www.bmz-central-service.com

DOCUMENT

Operating Instructions Supercore

Version: 0.2

As of 14.11.2019

Subject to change.



IMPORTANT

Carefully read the operating instructions before using the e-bike battery.

These operating instructions contain necessary information on the correct use of the rechargeable e-bike battery. They are directed towards the end user.

Keep these instructions accessible to all battery users.

DESCRIPTION OF ILLUSTRATIONS

Symbol	Description
 WARNING	Non-compliance can lead to severe injury or death. Medium risk level.
 CAUTION	Non-compliance may lead to slight or less severe personal injury. Low risk level.
NOTICE	Non-compliance can lead to property damage.
	Tips, additional information

CONTENTS

1	Product Description	5
1.1	Overview	5
1.2	Intended use	5
1.3	Technical data	5
1.4	LED display	5
1.5	Compatible Charger	5
1.6	Labeling	6
2	Safety	7
2.1	Safety Advice	7
2.1.1	General Safety Advice	7
2.1.2	Safety Advice for People with implants	7
2.2	Emergency Information	7
2.2.1	First-aid measures	7
2.2.2	Fire fighting measures	8
3	Operation	9
3.1	Safety Advice	9
3.2	Switch on	9
3.3	Charging	9
3.4	Switch Off	9
3.5	Troubleshooting	9
3.6	Cleaning	9
4	Storage and Transportation	10
4.1	Storage	10
4.2	Transportation	10
4.2.1	Dispatch	10
4.2.2	Transport on public roads	10
5	Disposal	11

1 PRODUCT DESCRIPTION

1.1 OVERVIEW

- A state of charge display
- B mounting/dismounting latch
- C charge/discharge socket
- D label (on the back)
- E power button

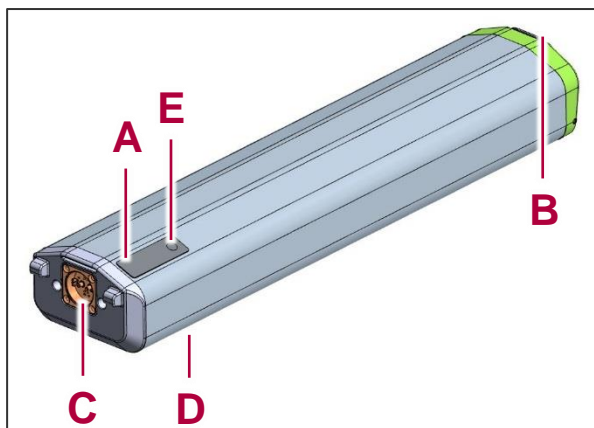

1.2 INTENDED USE

The battery supplies the e-bike with power. It may only be used with compatible, designated drive systems and chargers.

Any other use is not in compliance with the intended application. The warranty will cease in case of non-compliant use.

1.3 TECHNICAL DATA

	10S3P	10S4P
Nominal Capacity	15 Ah	20 Ah
Energy	555 Wh	750 Wh
Max. permanent discharge current	25 A	
Max. permanent charge current	5 A	
Voltage	36 V	
Max. Charge Voltage	42 V	
Weight	3,30 kg	3,79 kg
Dimensions in mm (B x H x L)	130 x 60 x 450	

1.4 LED DISPLAY

LED DISPLAY AND POWER BUTTON

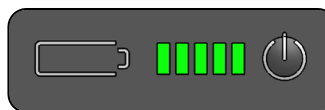

DESCRIPTION OF SYMBOLS

Symbol	Meaning
●	LED on
○	LED off
*	LED blinking

DISPLAY OF STATO OF CHARGE

Shortly press the power button to display the charge level.

LED 1, 2, 3, 4, 5	State of Charge
●●●●●	100...80 %
●●●●○	79...60 %
●●●○●	59...40 %
●●○○○	39...20 %
●○○○○	19...10 %
*○○○○	9...0 % Re-charge within two days to avoid permanent damage to the battery.

1.5 COMPATIBLE CHARGER





- Art. No. 28555
Charger 10S | 42 V | 4,5 A | 100-240 VAC

1.6 LABELING

EXAMPLE LABEL

Rechargeable Li-ion Battery
10INR22/71-4

Nominal Voltage: 37.0 Vdc
 Energy: 750.0 Wh
 Capacity: 20.0 Ah
 S/N: BH00000001

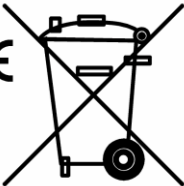
Brose
 MY 2019

CAUTION:
 Risk of fire and burns. Do not open, crush, heat above 80°C (176°F) or incinerate. Follow manufacturer's instructions. Charge: 0 to 45°C. Discharge: -20 to +60°C.
 Made in Germany GEB 18-W43 / Art.: 37146-00 / F123456

www.brose.com
 Brose GmbH - Am Spornplatz 28 - 63739 Kassel am Main

SYMBOLS

Symbol	Description
 Li-ion	Lithium-ion battery symbol (contains recyclable materials)
	Conformity with relevant European directives
	General warning symbol
	Do not immerse in liquids.
	Do not throw into fire.
	Do not charge broken battery.
	Follow operating instructions.
	Do not dispose in domestic or industrial waste.

2 SAFETY

When misused, lithium-ion batteries pose a threat of explosion and fire. Adhere to safety advice to minimize risks and to avoid misuse.

2.1 SAFETY ADVICE

2.1.1 GENERAL SAFETY ADVICE

 WARNING
<p>Non-compliance with safety advice can lead to personal injury.</p> <p>Non-compliance with safety advice can lead to fire and/or severe personal injury. Injury through chemical substances is also possible.</p> <p>► Follow safety instructions.</p>

- **Caution:** Remove battery from e-bike for handling (i. e. maintenance), transportation or storage. Unintentional activation of the e-bike poses risk of injury and/or damage.
- Use the battery and equipment only if in proper condition.
- Never use a damaged or broken battery.
- Only use the battery that is approved for your e-bike.
- Only use the battery that is approved for your e-bike.
- Use this battery only in e-bikes with BMZ systems. Your battery is only protected from dangerous overloading if used in the intended application.
- Charge the battery before use. Only use the supplied charger which was part of your delivery scope.
- Keep the battery and its contacts clean and dry. Remove any dirt with a clean and dry cloth.
- Do not use any solvents (i. e. dilution, alcohol, oil, anti-corrosives), detergents, or running water to clean the battery.
- Persons (including children) with reduced physical, sensory or mental abilities or lack of experience and knowledge may not use the battery, unless they are supervised and instructed by a person responsible for their safety.
- Do not expose the battery to strong mechanical impacts. It poses a risk of damage to the battery.
- Do not allow children to play with the battery.

- Do not open or dismantle the battery.
- Do not expose the battery to drastic temperature changes.
- Protect the battery from temperatures above 140 °F (60 °C), direct sunlight, and fire. Excessive heat may result in battery leakage and damage to the casing.
- Do not immerse the battery in any liquid. Do not clean with high-pressure cleaner.
- Do not use the battery if contacts are damaged. Do not use with damaged power cables.

2.1.2 SAFETY ADVICE FOR PEOPLE WITH IMPLANTS

- The charging socket of the battery contains a magnet. Keep the magnet away from your implant, as recommended by your physician.
- Due to technical reasons, electromagnetic (non-ionizing) radiation is generated at the electrical lines. Implant carriers should not be in the immediate vicinity of the radiation.

2.2 EMERGENCY INFORMATION

2.2.1 FIRST-AID MEASURES

Medical aid will be required in case of symptoms caused by combustion gases or leakage.

AFTER INHALATION

In case of damage or improper use chemical gases may leak. Leave area immediately and breath fresh air. Seek medical advice in case of any symptoms. Gases may cause respiratory irritation.

AFTER SKIN CONTACT

Remove solid parts immediately. Flush affected areas with plenty of water (at least for 15 min). Carefully pad dry affected areas– do not rub. Remove contaminated clothes immediately. Seek for medical attention if skin shows redness or irritation.



AFTER EYE CONTACT

Flush eye gently with plenty of water (at least for 15 min). Shield unaffected eye. Seek for medical assistance immediately.

AFTER INGESTION

Drink plenty of milk or water and induce vomiting. Seek medical attention immediately.

2.2.2 FIRE FIGHTING MEASURES

 WARNING	
	<p>Inhaling smoke can cause poisoning.</p> <ul style="list-style-type: none">▶ When facing the fire, position yourself with wind in your back.▶ If possible, use breathing protection.

1. If possible, remove other batteries carefully.
2. Evacuate all persons from immediate area of fire.
3. To fight the fire use plenty of water or a class D fire extinguisher.
4. Call the fire department if fire cannot be extinguished or controlled.

3 OPERATION

3.1 SAFETY ADVICE

Only use a battery that has been approved for use in your e-bike. Check if the battery and housing are intact before use.

Turn off the battery before inserting or removing it. Check if the battery is properly locked in place and securely attached before each ride. Chapter 2.1 and 4 contain detailed safety advice on the use and transportation of the battery.

3.2 SWITCHING ON

Shortly press the power button to switch on the battery. LEDs will sequentially light up and go out again.

3.3 CHARGING

Only use the charger that was supplied with your e-bike.

Follow the operating manual of the charger.

i After connecting the battery to the charger, the charger might blink red up to five times. Then the LED display changes to green and charging begins.

LEDs change to solid green as charging progresses:

LED 1, 2, 3, 4, 5	State of Charge
*○○○○	0...19 %
●*○○○	20...39 %
●●*○○	40...59 %
●●●*○	60...79 %
●●●●*	80...99 %
●●●●●	100 %

STATE OF CHARGE IN PERCENTAGE

3.4 SWITCHING OFF

To switch off the battery keep power button pressed until all LEDs have turned off.

Battery will turn off automatically if not in use.

3.5 TROUBLESHOOTING

Problem	Possible Solution
All LEDs are blinking	Battery is damaged. Contact your vendor.
First LED blinks	Battery is empty. Charge battery.
Mechanical defect	Check-up by vendor.
Battery does not work.	Contact your vendor.

3.6 CLEANING

If necessary, clean latch and lightly apply bike chain lubricant spray.

If necessary, clean battery with dry and clean cloth.

Keep battery contacts and sockets clean. Wipe with clean and dry cloth, if necessary.

4 STORAGE AND TRANSPORTATION

4.1 STORAGE

SAFETY PROVISIONS

- Remove battery from e-bike or charger when it is not in use.
- Do not store battery near hot or inflammable objects. Danger of explosion.
- Temperatures above 140 °F (60 °C) may lead to leakage and damage to battery's casing. Avoid contact with leaked substance.
- Do not store battery near heaters. Protect battery from direct sunlight.
- Store battery in a dry place away from flames and food.
- Keep small metallic objects away from the battery. They may accidentally bridge contacts.

RECOMMENDATIONS FOR BEST LIFE SPAN

- Store battery with a charge level of 50 %. Check charge level every three months (if not in use) and recharge to 50 %, if necessary.
- Store battery protect from freezing temperatures.
- Avoid drastic temperature changes.
- Recommended storage temperature: 72...79 °F (22...26 °C)

4.2 TRANSPORTATION

4.2.1 DISPATCH

The battery is categorized as a dangerous good and may only be packaged and dispatched by especially trained personnel. Contact your vendor for more information.

4.2.2 TRANSPORT ON PUBLIC ROADS

Private users may transport their battery on public roads without any restrictions.

Commercial users or third parties transporting lithium-ion batteries need to adhere to respective dangerous goods regulations.

5 DISPOSAL

Do not dispose your old battery with your household waste. In EC countries it is mandatory to return batteries. Returning old batteries is free of charge. To avoid a short circuit, fully discharge the battery and cover its poles with adhesive tape.

If batteries are not disposed of properly, they pose a risk of fire, health and environmental hazards.

DROP-OFF POINTS

- Manufacturer
- E-bike vendor
- Local recycling centers

**BMZ GmbH**

Zeche Gustav 1
63791 Karlstein am Main
Germany
Phone +49 61 88-9956-0
Fax +49 61 88-9956-900
kontakt@bmz-group.com

Web

www.bmz-group.com

Service

centralservice@bmz-group.com

BMZ Company Ltd.

2nd Building, NO.2 Jinlong Street
Baolong Industry Zone, Longgang
518116 Shenzhen
China
Phone +86 755 89775-800
Fax +86 755 89775-900
sales@bmz-group.com

BMZ USA Inc.

2656 Lishelle Place
Virginia Beach, VA 23452
USA
Phone +1 757 821-8494
Fax +1 757 821-8499
bmz-usa@bmz-group.com

BMZ Poland Sp. z o.o.

Alberta Einsteina 9
PL-44-109 Gliwice
Poland
Phone +48 32 7842-450
Fax +48 32 7842-451
biuro@bmz-group.com

BMZ France S.A.R.L.

153, Boulevard Haussmann
75008 Paris
France
Phone +33 6 84 52 76 29
jean-marc.brunet@bmz-group.com